

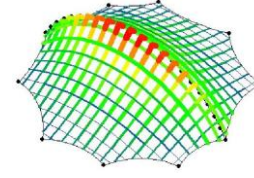

ŞENOL MAKİNA



SNL
tensi



TEXTILE ROOFS

STEEL WIRE ROPES AND END FITTINGS EQUIPMENTS USAGE PRINCIPLES IN LIGHTWEIGHT STRUCTURES

BAHADIR SENOL

SNL TENSI

BRAND MANAGER

WHO WE ARE?

- ESTABLISH 1972 / TURAN SENOL
HOT FORGED PRODUCTION, HYDRAULIC PRESS PRODUCTION
- 1996 LIMITED COMPANY / HALIT & TUNCAY SENOL BROTHERS
LIFTING EQUIPMENTS
- 2002 STEEL WIRE ROPES AND END FITTINGS EQUIPMENTS PRODUCTION
SPECIAL SOLUTIONS FOR LIGHTWEIGHT STRUCTURES
- 2011 ACHIVED EU STANDARTS STEEL WIRE ROPE SWAGING MACHINES & TENSILE TEST MACHINES
EXPORT AND INTERNATIONAL EXHIBITION ATTENDANCE
- 2019 STOP DEAL WITH RETAIL MARKET
FOCUS ON PROJECT WHERE WE CAN CREATE DIFFERENCE



ŞENOL MAKİNA



SNL
tensi

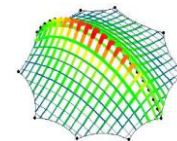

TEXTILE ROOFS

PRODUCTION

- 1000 M2 CLOSED AREA HOT FORGED AND THREATING OPERATIONS
- CNC TURNING MACHINES
- CNC DRILLING MACINES
- MANUEL TURNING MACHINES
- 1500T FORGING HAMMER
- HYDRAULIC SWAGERS (SEVERAL TONANGES)
- FULL AUTOMATED CUTTING MACHINES
- SWAGE THREAD ENDING MACHINES
- PAINTING PROCESS

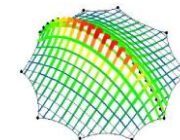

TEXTILE ROOFS



"Manufacture and Sales Of Junction Parts for
Guy and Chain, Load Uptake and Stretching Materials."



"The subject of manufacturing load uptake and lifting equipments that are our main business occupation, we have answered upon demands of our customers with imports that are added to 37 years manufacturer profile of us. We would take pride to be on your side as a family of ŞENOL MAKİNA in the international markets the subject of disburden without compromising our quality standarts for years that we certified."



Evliya Çelebi Mah. Ümmet Sok. No: 19 Tuzla / İSTANBUL-TR Tel: +90 216 446 84 87 pbx / Fax : +90 216 446 98 87

www.senolmakina.com

WAREHOUSE

- 2000 M2 STOCK AND PRODUCTION AREA
- 450T, 700T, 1100T HYDRAULIC SWAGING MACHINES



"Steel Wire Ropes and Steel Wire Slings,
Crescent Series Hydraulic Swaging Machines"



"Crescent series Hydraulic Swaging Machines are designed to achieve safe and efficient mechanical splicing of steel wire ropes with many types of ending fittings, especially Steel Wire Rope and Steel Construction industry considering all the needs, technology and safety rules. Şenol Makina proudly supplying the machines, related equipments and fittings equipments to more than 15 countries since 1974."



www.snltensi.com

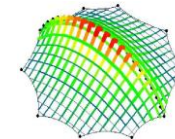
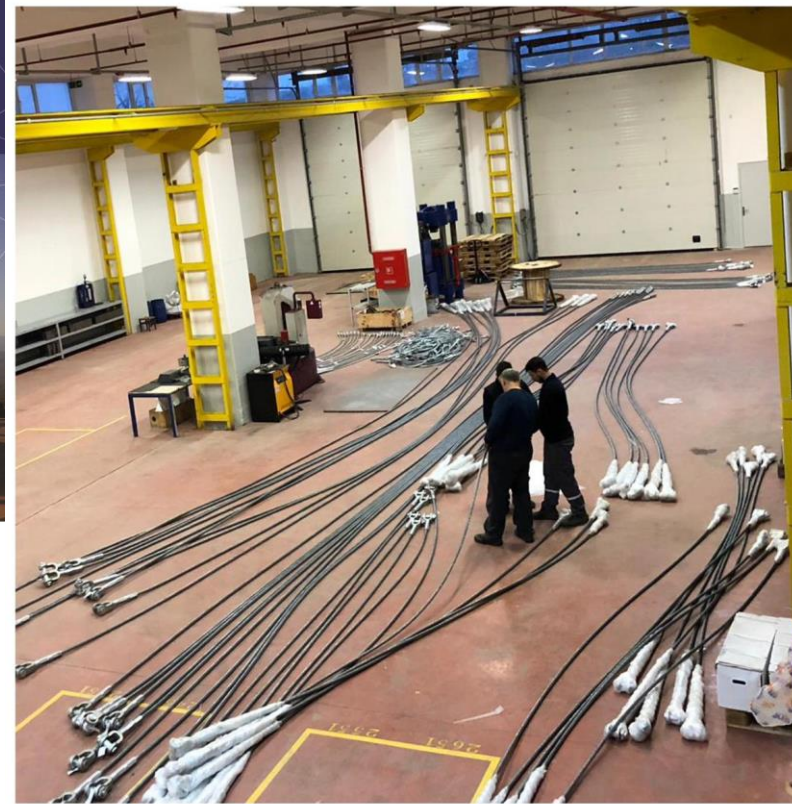

TEXTILE ROOFS

SWAGERS AND SWAGING OPERATIONS



ŞENOL MAKİNA



SNL
tensi

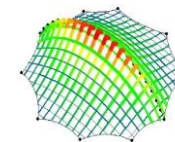

TEXTILE ROOFS

WHERE WE ARE?

- Our new facility with 2000m² closed area is in Istanbul where Europe is connected to Asia. Sabiha Gokcen Airport (10km) and Pendik RORO port (15km) which enables us to provide high quality products and services at global level in the shortest time.



WHAT WE DO FOR THE LIGHT WEIGHT STURCTURES SYSTEMS?



SNL
tensi



SNL
wire



SNL
tensi

CHROME



ŞENOL MAKİNA



SNL
tensi

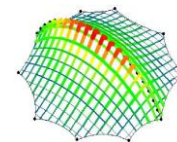

TEXTILE ROOFS

MAIN COMPONENTS FOR TENSILE STRUCTURES

- 1. STEEL / ALU. / WOOD
- 2. TEXTILE / MEMBRANE
- 3. ROPES / CABLES



ŞENOL MAKİNA



SNL
tensi

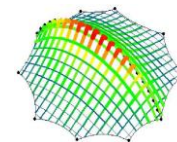

TEXTILE ROOFS

STEEL WIRE ROPES

- COMPONENTS OF STEEL WIRE ROPES

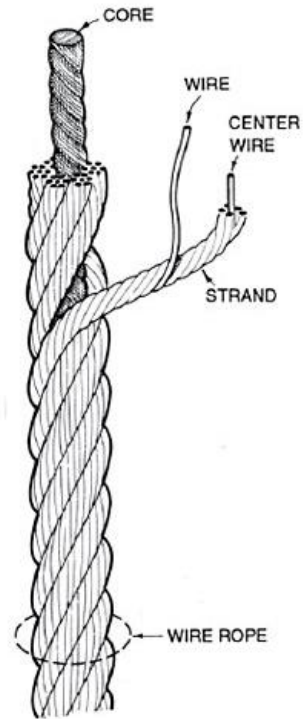

- LAYS AND DIRECTIONS

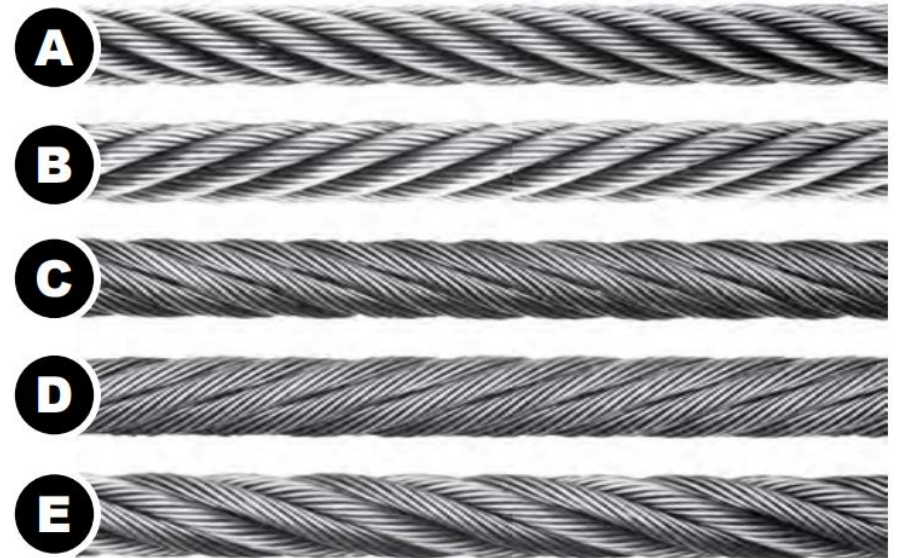

STEEL WIRE ROPES

- MULTI STRAND ROPES



- SPIRAL STRAND ROPES

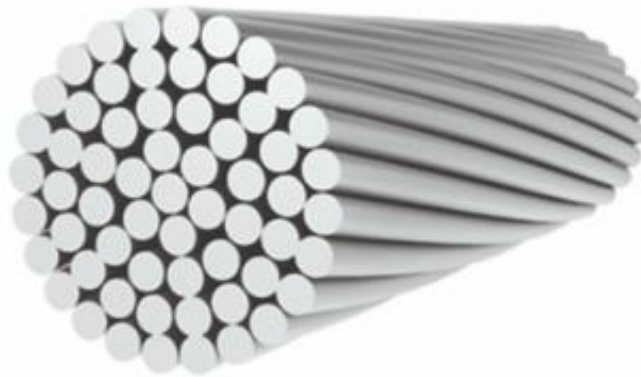

- LOCKED COIL ROPES

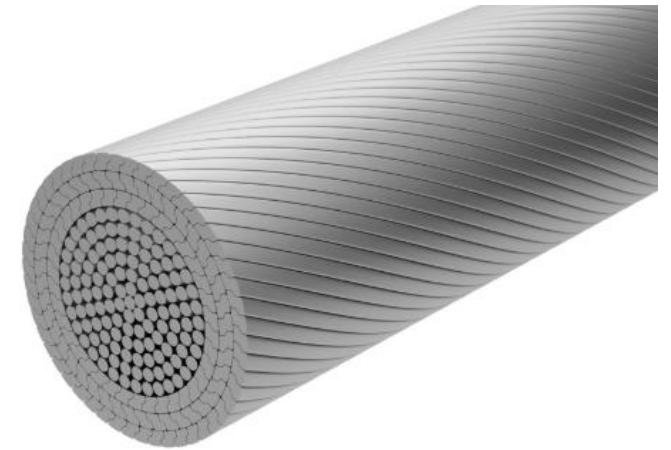

ŞENOL MAKİNA



SNL
tensi

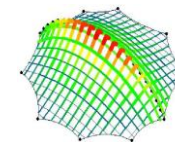

TEXTILE ROOFS

STEEL WIRE ROPES / USAGE AREA

■ MULTI STRAND ROPES

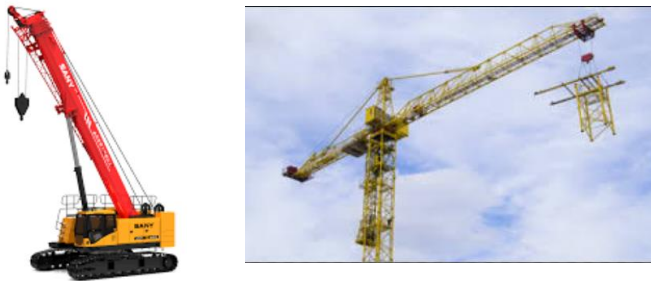

ŞENOL MAKİNA

■ SPIRAL STRAND ROPES



SNL
tensi

■ LOCKED COIL ROPES

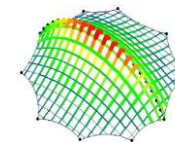

TEXTILE ROOFS

STEEL WIRE ROPES / MULTI – SPIRAL COMPARISON

DIA (mm)	PRICE (€/MT)		MBL (TON)	
	6X19	1X19	6X19	1X19
10	SAME	SAME	6,0	9,8
12	SAME	SAME	8,6	14,0
14	SAME	SAME	11,7	19,3
16	SAME	SAME	15,3	25,1
18	X	X.%10	19,3	31,8
	6X19	1X37	6X19	1X37
20	X	X.%15	23,8	38,9
22	X	X.%15	28,8	46,1
24	X	X.%15	34,5	55,4

SAME PRICE/ 65% EXTRA MBL

%15 MORE EXP. / %60 EXTRA MBL

END FITTINGS OPTIONS

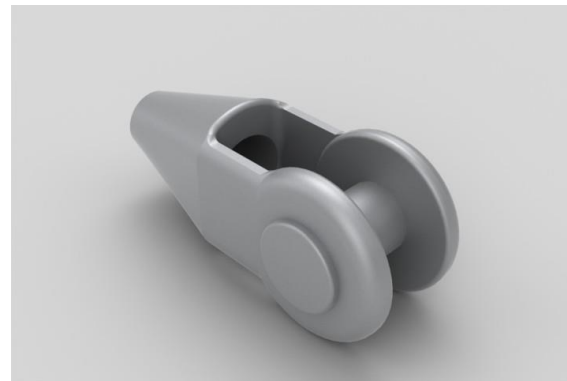
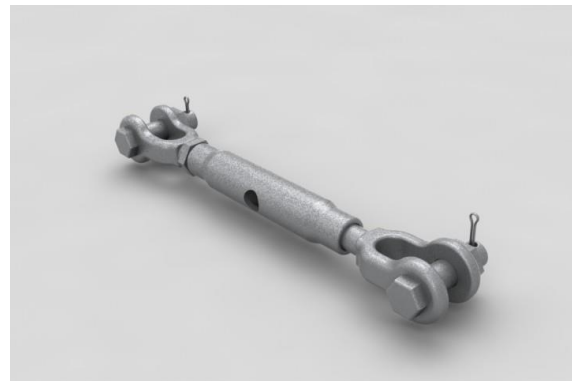
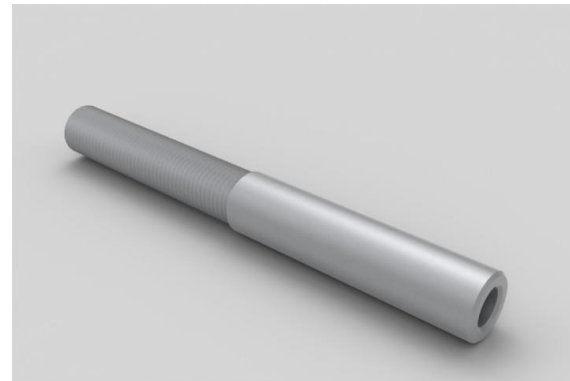

END FITTINGS OPTIONS

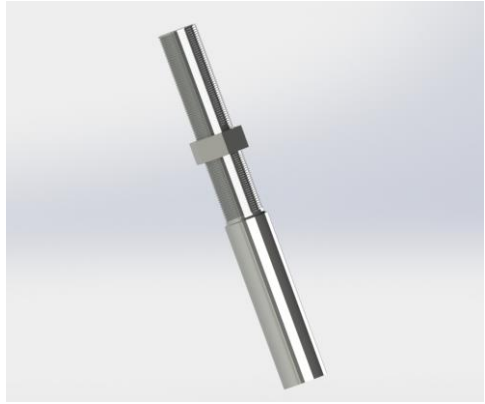

ŞENOL MAKİNA



SNL
tensi

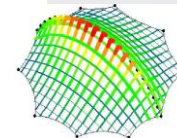

TEXTILE ROOFS

END FITTINGS OPTIONS

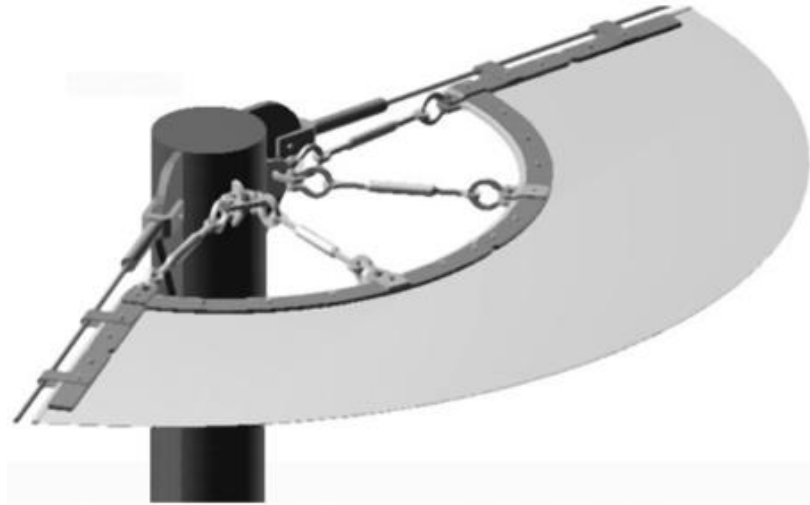



ÇELİK HALAT SONLANDIRMA TÜRLERİ WIRE ROPE ENDING TYPES

► Halat ucu sonlandırma işlemleri halatın kopma kapasitesini azaltır. Belirtilen yüzdeler minimum kopma yüklerinin oranıdır.
Wire rope fittings operations can not provide the same performance as unwaged. Percentages refer to minimum breaking loads.

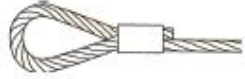

%90

Alüminyum Ferrule
Yüzük Pres Baskı (DIN 3088)
Aluminium Ferrule Swaged Slag



%80

El Örgüsü Çelik Radansalı Sapan
(DIN 3088) (Bazı Halat Kom-
pozisyonları için % 50 Kadar Güç
Kaybı alabilir)
Hand Woven Steel Eye Slag With Thimbles



%80

El Örgüsü Çelik Sapan
Hand Woven Steel Slag



%85

Klemensli (DIN 1142) Çelik Sapan
Steel Slag With Clips



%80

Çelik Radansalı (DIN 3093)
Alüminyum Ferrule Yüzük Pres Baskı
Aluminium Ferrule Swaged Slag
With Steel Thimbles

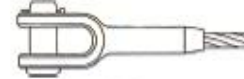

%90

Preslenmiş Çelik Çatal Baskı
Swaged Steel Fork



%90

Preslenmiş Çelik Mapa Baskı
Swaged Steel Eye



%90

Preslenmiş Çelik Saplama Baskı
Swaged Steel Stud

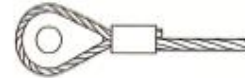

%90

Çelik Dolu Radansalı (DIN 3091)
Alüminyum Ferrule Yüzük Pres Baskı
Aluminium Ferrule Swaged Slag With Steel Thimbles



%80

Açık Ağız Soket (DIN 15315)
Open Type Socket

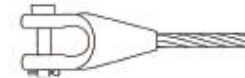

%100

Açık Ağız Dökme Yapıştırma
Soket Sistemi (DIN 8313)
Open Type Socket With Wire Lock

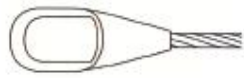

%100

Kapalı Ağız Dökme Yapıştırma Soket
Sistemi (DIN 8313)
Closed Type Socket With Wire Lock

TEST RESULTS



- EN 13411-8
EFFICIENCY %90



- EN 13411-8
EFFICIENCY %90



- EN 13411-8
EFFICIENCY %90

TEST RESULTS



- EN 13411-4
EFFICIENCY ~ %100



- EN 13411-3
EFFICIENCY %90

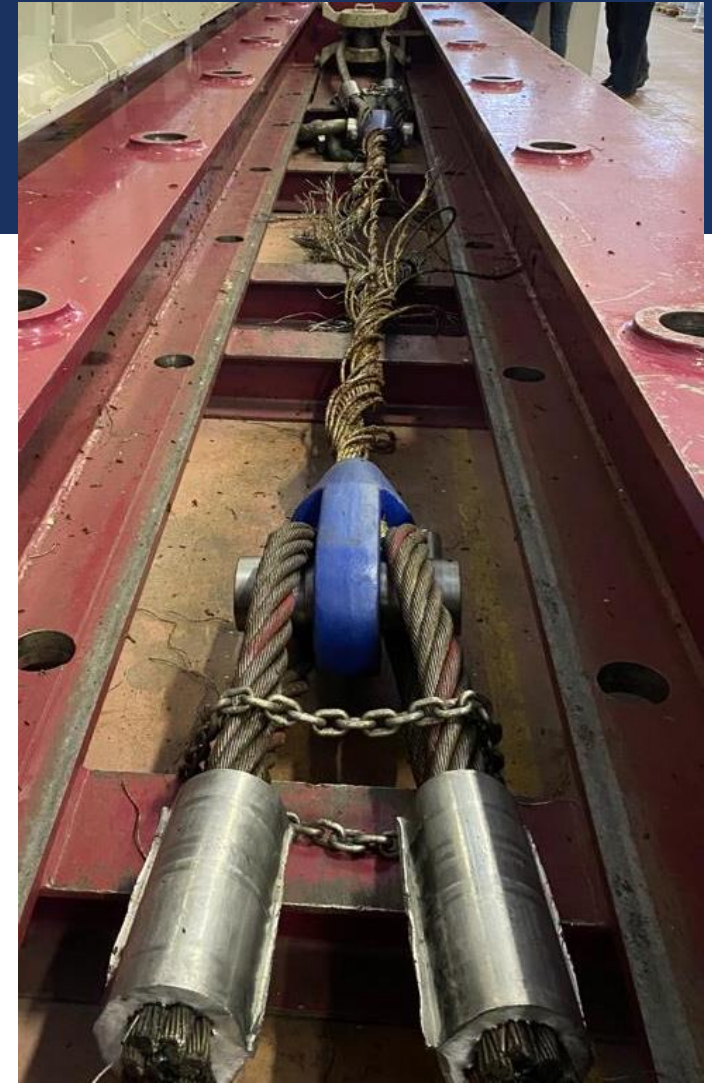

ASSEMBLIES



ŞENOL MAKİNA



SNL
tensi

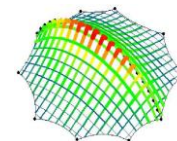

TEXTILE ROOFS

STEEL WIRE ROPE ENGINEERING

- SAFETY FACTOR
- THE RIGHT MATERIAL
- TEST REPORTS
- INSPECTION
- CERTIFICATION



SAFETY FACTOR

- EN 2006/42
- VERTICAL LOADS
- FOR WIRE SLINGS
- LIFTING AND CARRYING
- MADE BY IRON AND STEEL



ŞENOL MAKİNA



SNL
tensi

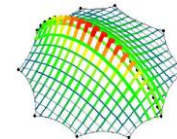

TEXTILE ROOFS

SAFETY FACTOR

- STEEL STRUCTURES
- EN 1993-1-11:2015 (2,25)
- TENSILE AND MEMBRANE STRUCTURES
- LIGHTWEIGHT STRUCTURES
- NOT DIRECT LIFTING OR CARRYING
- CLIMATE CONDITIONS!

2/1
3/1

LENGHT

- NOT ONLY PIN TO PIN DIMENSIONS!
- CONSIDER;
 - AFTER LOADING BEHAVIES (CABLE CREEPS)
 - CUTTING TEMPRETURE AND DESIGN TEMPRETURE
 - ADDITIONAL ELONGATION DUE TO END FITTINGS
 - CLIMATE
 - TOLERANCES



ŞENOL MAKİNA



SNL
tensi

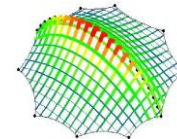

TEXTILE ROOFS

ELASTIC ELONGATION

ΔL_{elast} : Elastic elongation

F_{sys} : System force of the cable

L_{sys} : System length of the cable

E: Modulus of elasticity

A: Metallic cross section

$$\Delta L_{\text{elast}} = (F_{\text{sys}} * L_{\text{sys}}) / (E * A)$$

SOME PROOF TEST RESULTS

Ø Wire Dia.	Length	Pre. Strecht	1 to 2t	1 to 4t	1 to 6t	1 to 8t	1 to 10t	1 to 12	1 to 15
10mm 1x19 1570N/mm ²	1000mm	1 ton	1003mm	1006mm	x	x	x	x	x
12mm 1x19 1570N/mm ²	1000mm	1 ton	1002mm	1004mm	1005mm	x	x	x	x
14mm 1x19 1570N/mm ²	1000mm	1 ton	1001mm	1004mm	1004mm	1005mm	x	x	x
16mm 1x19 1570N/mm ²	1000mm	1 ton	1000mm	1003mm	1004mm	1004mm	1005mm	x	x
18mm 1x19 1570N/mm ²	1000mm	1 ton	1000mm	1003mm	1003mm	1003mm	1004mm	1005mm	x
20mm 1x19 1570N/mm ²	1000mm	1 ton	1000mm	1002mm	1003mm	1003mm	1003mm	1004mm	1005mm



ŞENOL MAKİNA



SNL
tensi

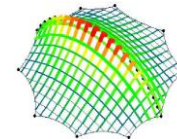

TEXTILE ROOFS

SOME PROOF TEST RESULTS

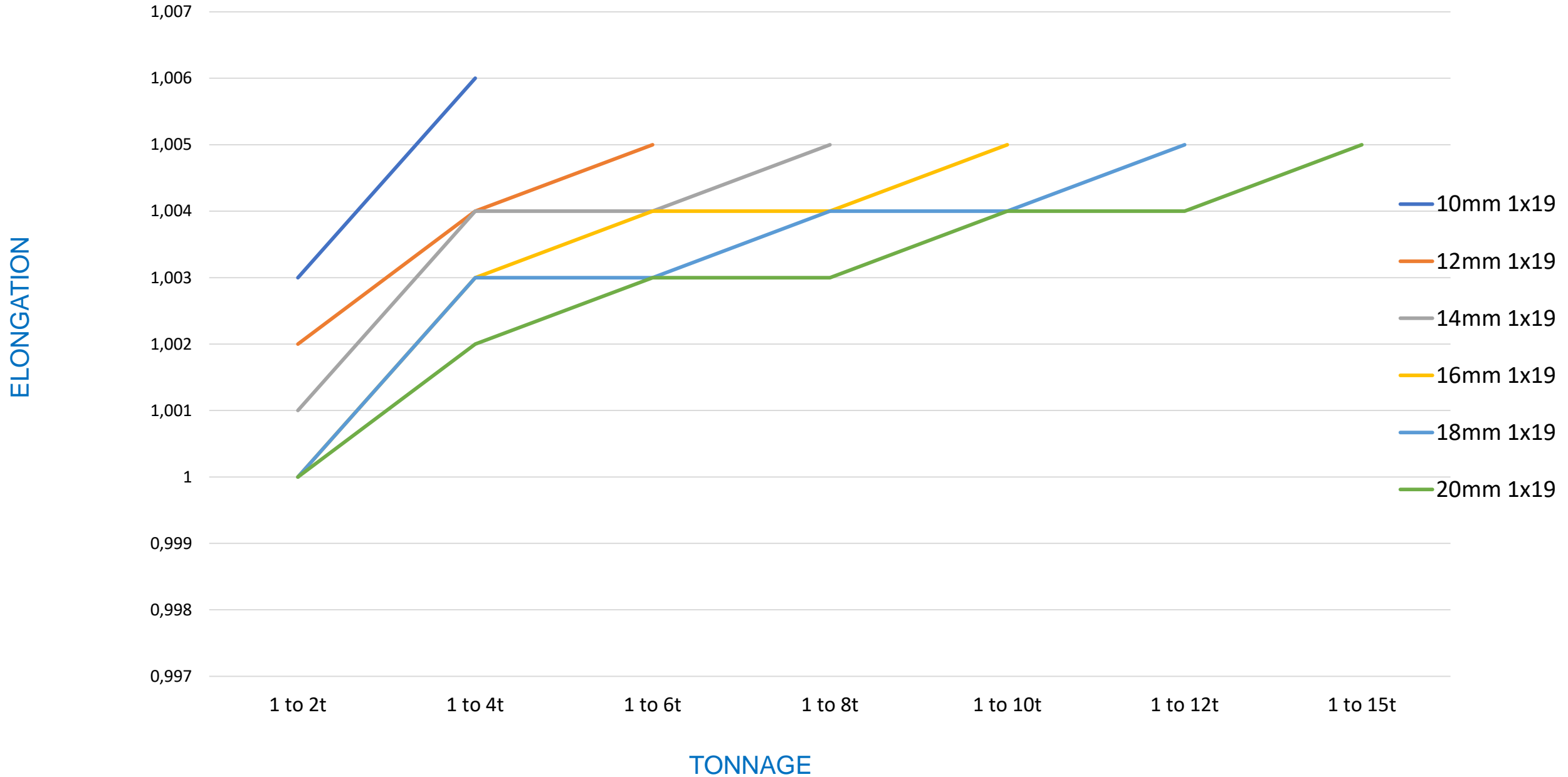

COATING

- ELECTRO GALVANISED
- HOT DIP GALVANISED
- GALFAN

- PAINTED



ŞENOL MAKİNA



SNL
tensi

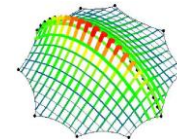

TEXTILE ROOFS

MUST

- CLOSE COOPERATION BETWEEN ARCHITECTS, STRUCTURAL ENGINEERS AND QUALIFIED MANUFACTURERS IS HIGHLY RECOMANDED TO DISCUSS AND SPECIFY ALL THE DETAILS.



ŞENOL MAKİNA



SNL
tensi



IMS BAUHAUS®

MANUFACTURING OF CABLE SYSTEMS

- RECEIVING ORDERS
- MEASURING
- SWAGING & SOCKETING
- TESTING (IF REQUIRED)
- PRE-STRECHT (IF REQUIRED)
- PACKING & TRANSPORTATION

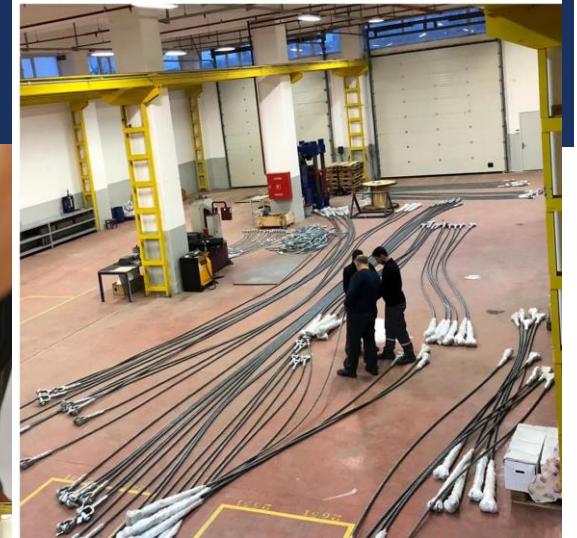
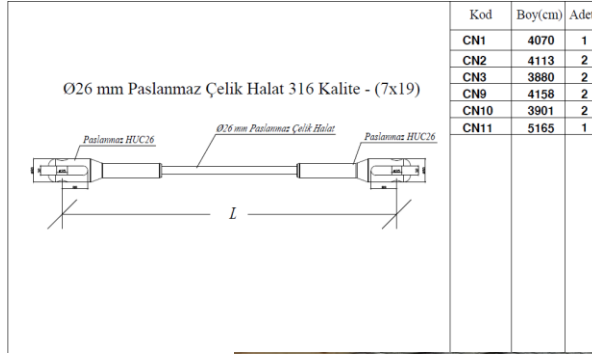

RETRACTABLE FABRIC ROOF SYSTEMS



REFFERANCE PROJECTS

- BAYRAKTEPE
SAKARYA / TÜRKİYE



ŞENOL MAKİNA



SNL
tensi

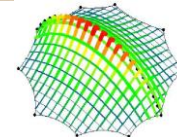

TEXTILE ROOFS

REFERANCE PROJECTS

- VIALAND MALL
ISTANBUL / TÜRKİYE

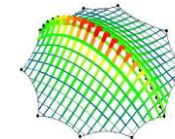

TEXTILE ROOFS

REFFERANCE PROJECTS



- CROCODILE ARENA
BURSA / TÜRKİYE



ŞENOL MAKİNA



SNL
tensi

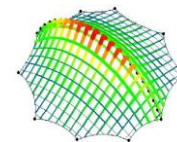

TEXTILE ROOFS

REFFERANCE PROJECTS

- FIRÜZKÖY STADIUM
İSTANBUL / TÜRKİYE



ŞENOL MAKİNA



SNL
tensi

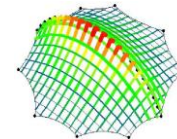

TEXTILE ROOFS

REFFERANCE PROJECTS

- GEDERA / ISRAEL



REFERANCE PROJECTS

- VIAPORT MALL
ISTANBUL / TÜRKİYE



ŞENOL MAKİNA



SNL
tensi

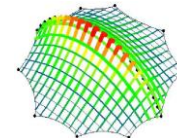

TEXTILE ROOFS

REFERANCE PROJECTS

- AZERSUN ARENA
SUREHANI / AZERBAIJAN

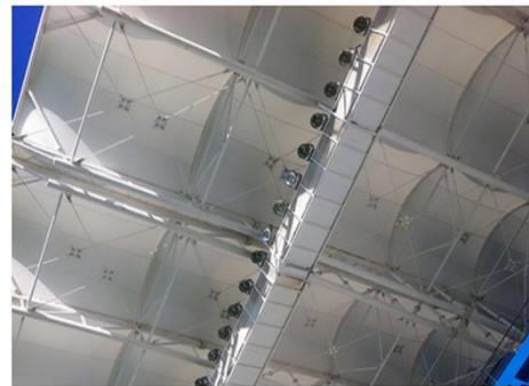
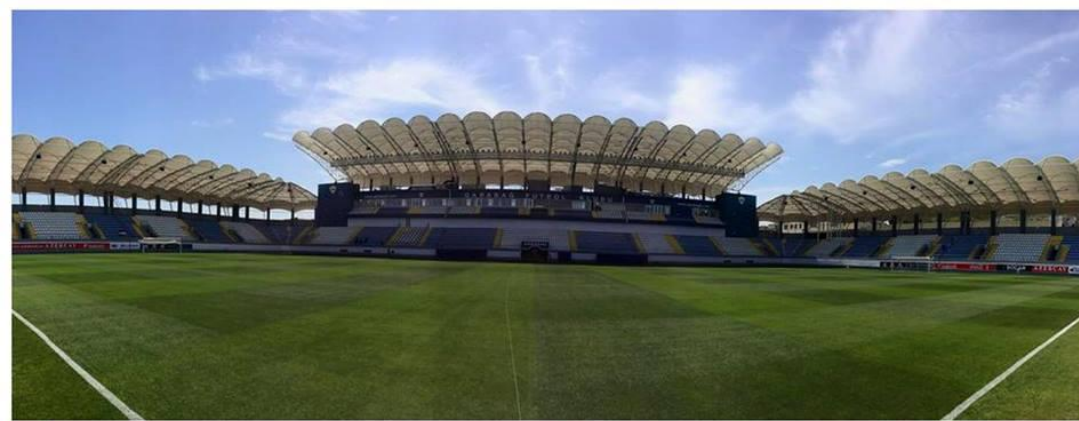

REFFERANCE PROJECTS

- KUŞADASI MARINA
AYDIN / TÜRKİYE

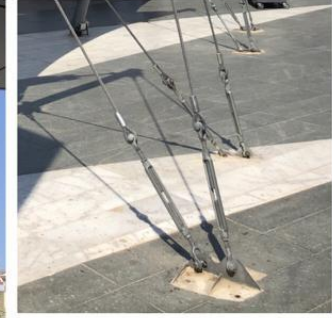

SNL
tensi



ŞENOL MAKİNA



SNL
tensi

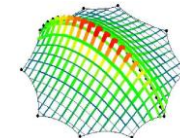

TEXTILE ROOFS

REFERANCE PROJECTS

- SUGAR FACTORY CANAL / EGYPT

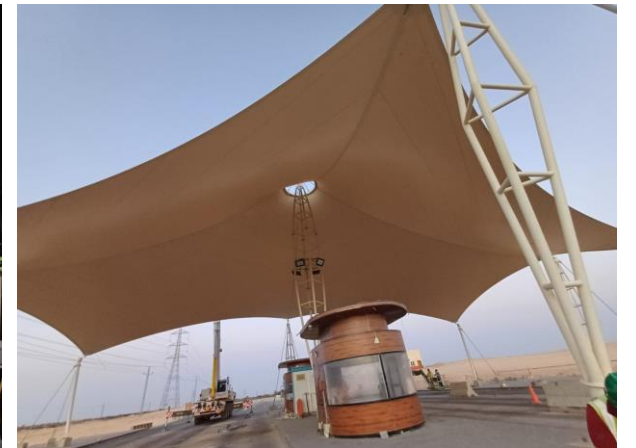

REFFERANCE PROJECTS

- THEME PARK
İSTANBUL / TÜRKİYE



REFERANCE PROJECTS

- RADISSON HOTEL
WARSAW / POLAND



ŞENOL MAKİNA



SNL
tensi

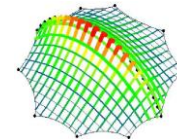

TEXTILE ROOFS

REFFERANCE PROJECTS

- NAIROBI / KENYA



REFFERANCE PROJECTS

■ AMPHITHEATRE
DJERBA / TUNUSIA



ŞENOL MAKİNA



SNL
tensi

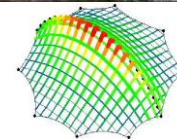

TEXTILE ROOFS

REFERANCE PROJECTS

- ALHUR PARK
KERBELA / IRAQ



ŞENOL MAKİNA



SNL
tensi

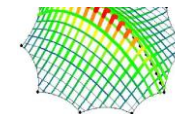

TEXTILE ROOFS

REFFERANCE PROJECTS

- ANGORA PARK
ANKARA / TÜRKİYE



ŞENOL MAKİNA



SNL
tensi

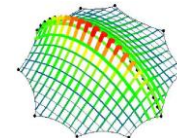

TEXTILE ROOFS

REFERANCE PROJECTS

- MALL OF ARABIA
CAIRO / EYGPT



ŞENOL MAKİNA



SNL
tensi

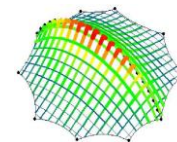

TEXTILE ROOFS

REFFERANCE PROJECTS

- ATAKÖY INT. YOUTH CENTER
ISTANBUL / TÜRKİYE



ŞENOL MAKİNA



SNL
tensi

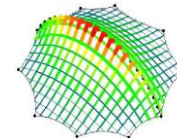

TEXTILE ROOFS

REFERANCE PROJECTS

- FIFA WOLD CUP
FOOD & BEVERAGE AREA
LUSAIL / QATAR

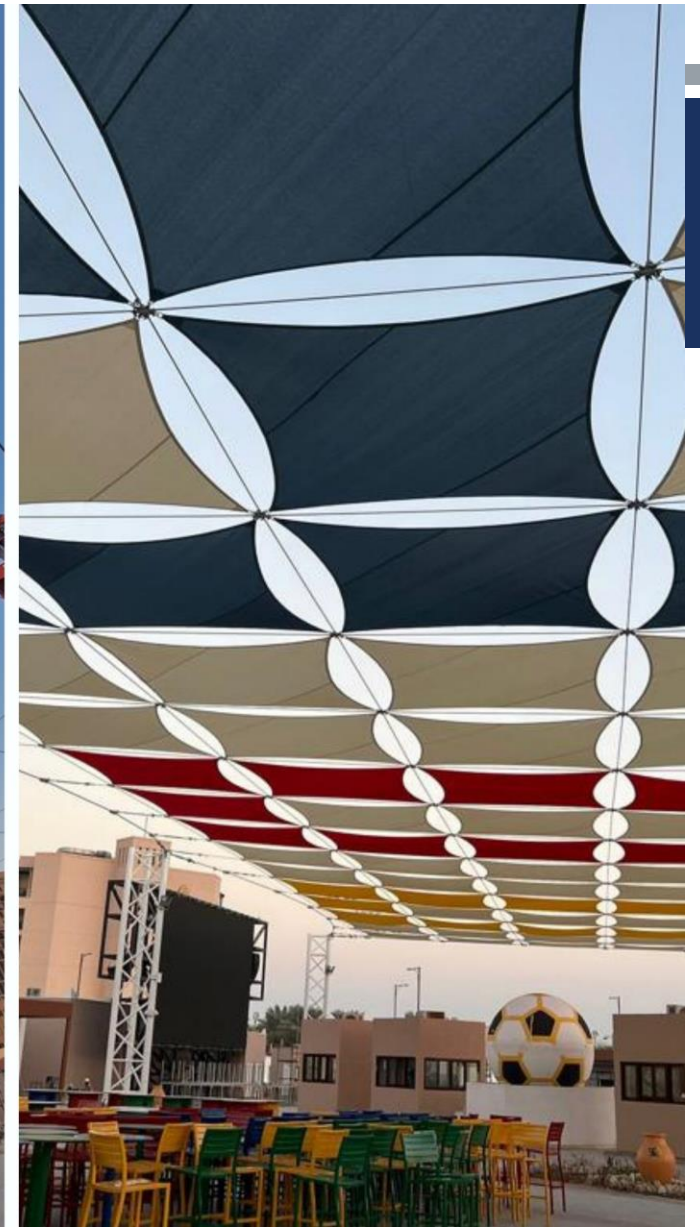
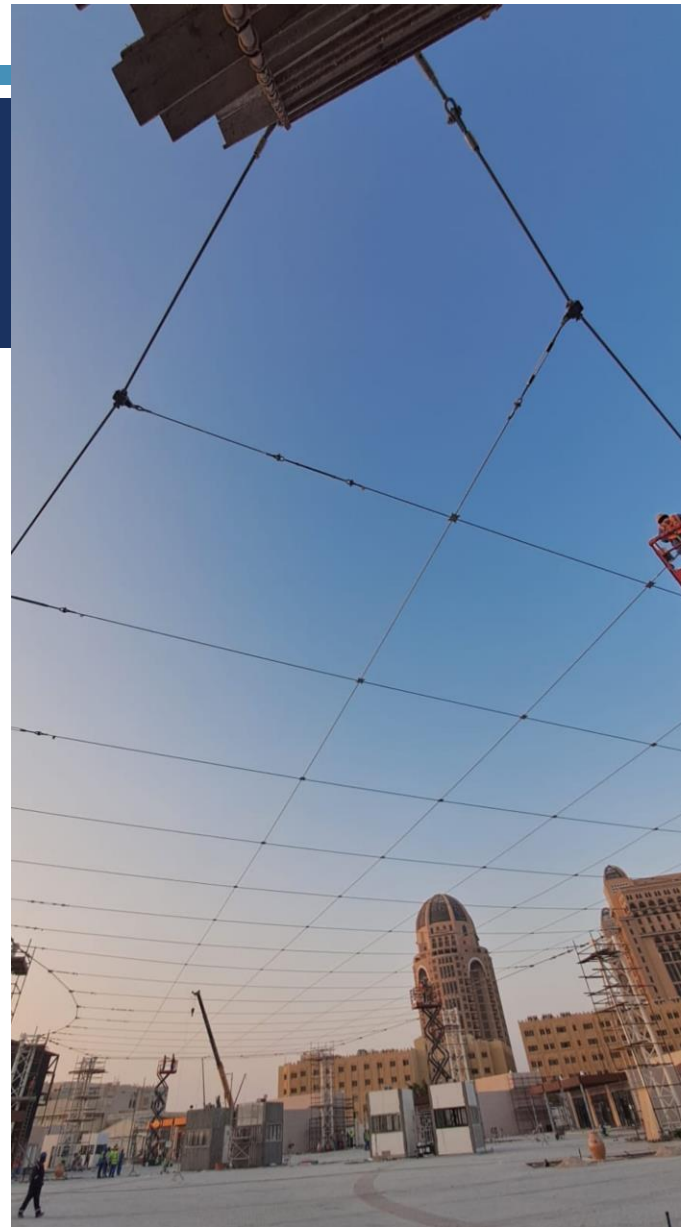

ŞENOL MAKİNA



SNL
tensi

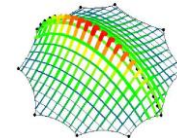

TEXTILE ROOFS



ŞENOL MAKİNA



SNL
tensi

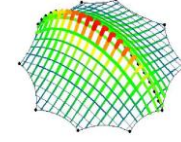

TEXTILE ROOFS

THANKS FOR YOUR PATIENCE

ANY QUESTION ?

CONTACT : BAHADIR@SENOLMAKINA.COM